



© Interactive Health®, 2006  
Patents Pending and intellectual property rights enforced.  
No medical claims are warranted or implied by the use of this product.  
HT is a trademark and HTT Human Touch Technology is a registered  
trademark of Interactive Health®, Inc.

[www.interhealth.com](http://www.interhealth.com)

HT-270-B0



ROBOTIC MASSAGE® CHAIR  
HT™ -270 USE & CARE MANUAL



# HT™-270

## ROBOTIC MASSAGE® CHAIR

YOU HAVE PURCHASED A TICKET TO  
**TRANQUILITY** – CONGRATULATIONS!

Your HT™-270 chair is the perfect bridge between state-of-the-art technology and the ancient healing art of massage. It's a key ingredient for a balanced life, conveniently designed for use at home.

Your HT™-270 chair incorporates Human Touch Technology®. The very latest Robotic Massage® system, HTT® emulates the same techniques used by massage and chiropractic professionals for back and spinal care. Superior technology, combined with a wide variety of massage modes and sleek design, means your HT™-270 chair will be a permanent fixture in your home for years to come.

To ensure that you don't overlook any of your chair's features, and that you use it safely, read this manual carefully. Then sit back, relax, and enjoy!



**Human TOUCH**  
ROBOTIC MASSAGE CHAIR

### Interactive Health® Partners in Your Well-Being

For decades, Interactive Health® has been a leader in the field of massage products. We create state-of-the-art products that embrace the latest technology while applying the ancient healing art of massage. Balancing your physical and mental needs requires the right mix of proper nutrition, exercise, and massage. Interactive Health® Massage Systems are vital components for achieving balance between physical and mental well-being.

To learn more about our company and our products, we invite you to visit us on the Internet at: [www.interhealth.com](http://www.interhealth.com) or call our Customer Service Representatives at 800-355-2762.



"HTT" is the preferred technology of the ACCO.  
[www.accoweb.org](http://www.accoweb.org)



# KEEP IT SAFE

Read all instructions before using this product.

**WARNING:** Do not put hands or fingers near the massage mechanism or rollers while this product is running. Touching the mechanism can result in injury from the rollers squeezing together.

**DANGER:** To reduce the risk of electrical shock  
Always unplug this product from the electrical outlet immediately after using and before cleaning. Do not reach for this product if it has fallen into water. Unplug immediately.

**WARNING:** To reduce the risk of burns, fire, electric shock or injury to persons

- This product should never be left unattended when plugged in.
- Unplug from outlet when not in use, and before putting on or taking off parts.
- Do not operate under blanket or pillow. Excessive heating can occur and cause fire, electric shock, or injury to persons.
- Close supervision is necessary when this product is used by, on, or near children, invalids, or disabled persons.
- Use this product only for its intended use as described in this manual. Do not use attachments not recommended by the manufacturer.
- Never operate this product if it has a damaged cord or plug, if it is not working properly, if it has been dropped or damaged, or dropped into water. Return this product to a service center for examination and repair.
- Always keep the power cord away from heated surfaces.
- Never operate this product with the air openings blocked. Keep the air openings free of lint, hair, and the like.
- Never drop or insert any object into any opening.
- Do not use outdoors.
- Do not operate where aerosol (spray) products are being used or where oxygen is being administered.
- To disconnect, turn all controls to the OFF position, then remove plug from outlet.
- Do not massage abdomen when pain is present or if you are pregnant.
- Do not massage any area of the body that is swollen, inflamed or covered with skin eruptions. Do not use on unexplained calf pain.
- Do not use this product when standing on a damp floor, or when any part of the body is in contact with plumbing or any similar ground.
- Always connect this product to a properly grounded electrical outlet.
- This product is designed to operate on standard 120 Volt 60 Hz house current.
- Do not use this product if noise above normal sound is heard.
- This product is designed for personal in-home use. Commercial use will void warranty.

## Safety Precautions

- Comfortable clothing is recommended while using this product.
- This product was meant to be used in a relaxed position. Never force any body part into the backrest area while the rollers are moving.
- Do not allow children to use this product.
- If you feel any abnormal discomfort during the operation of this product, turn off the power immediately and do not use the product. Consult your physician.
- Do not sit on the controller.
- Do not pull on the AC cord.
- Always confirm that there are no obstacles behind the product and that there is sufficient space to recline.
- When using this product after it has been in storage, check to see that the product is operating properly prior to sitting in the product.
- **Do not attempt to repair this product yourself.**  
If a malfunction occurs, please contact Interactive Health® at (800) 355-2762.

## SAVE THESE INSTRUCTIONS

For all grounded cord-connected products:

### Grounding methods:

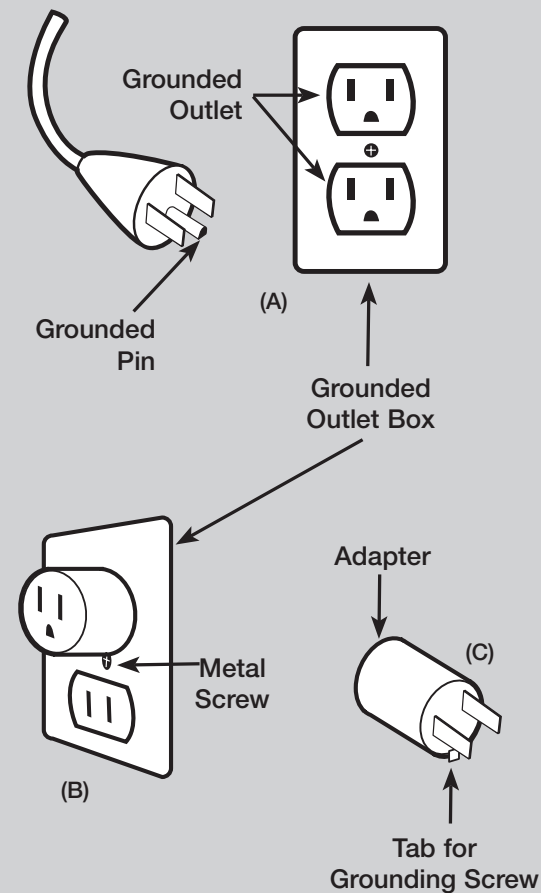

The use of a temporary adaptor is not permitted in Canada.

### Grounding Instructions:

This product must be grounded. If it should malfunction or breakdown, grounding provides a path of least resistance for electrical current to reduce the risk of electric shock. This product is equipped with a cord having an equipment-grounding conductor and a grounding plug. The plug must be plugged into an appropriate outlet that is properly installed and grounded in accordance with all local codes and ordinances.

**WARNING:** Improper connection of the equipment-grounding conductor can result in a risk of electronic shock. Check with a qualified electrician or serviceman if you are in doubt as to whether this product is properly grounded. Do not modify the plug provided with the product – if it will not fit the outlet, have a proper outlet installed by a qualified electrician.

This product is for use on a normal 120-volt circuit and has a grounding plug that looks like the plug illustrated in sketch (A). A temporary adapter that looks like the adapter used in sketches (B) and (C) may be used to connect this plug to a 2-pole receptacle as shown in sketch (B), if a properly grounded plug is not available. The temporary adapter should be used only until a properly grounded outlet (sketch A) can be installed by a qualified electrician. The green colored, rigid ear tab or the like extending from the adapter must be connected to a permanent ground such as a properly grounded outlet box cover. Whenever the adapter is used, it must be held in place by a metal screw.

**WARNING:** This product is equipped with a thermal resetting protection device. This is an added safety feature to protect you and this product from overheating. If the product should suddenly stop and will not start, turn the main power switch, located on the back of the product, off and do not operate the product for at least 30 minutes. Failure to turn the product off may result in the product starting unexpectedly when the device cools.

# GET READY

## Unpack the box

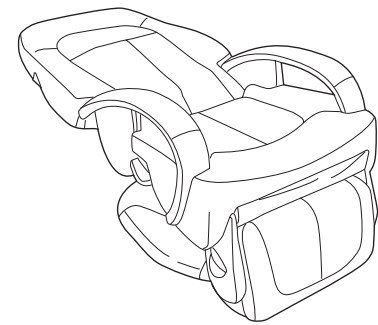

Chair

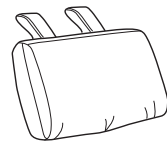

Head Pillow



- 1. Remove all packaging materials from the chair, then plug the power cord into a 110-volt wall outlet.**

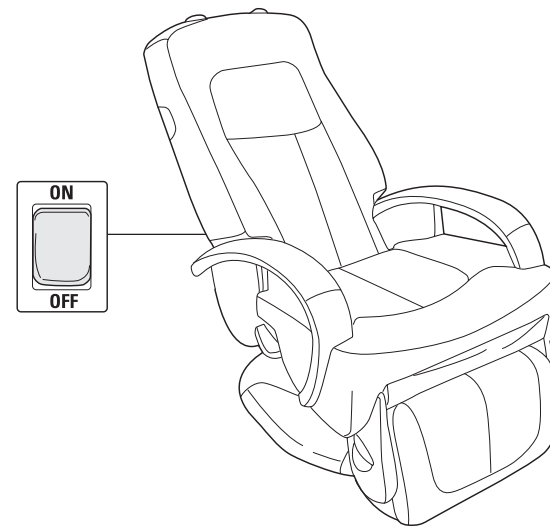

- 2. Power on**

Turn the master power switch to On (located on the bottom center of the chair back).

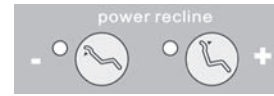

- 3. Raise the backrest**

Use the remote control to raise the backrest to an upright position.

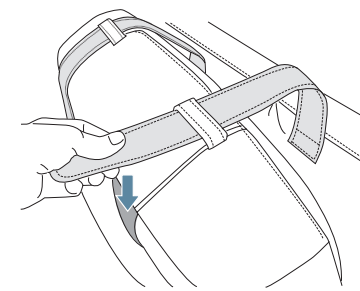
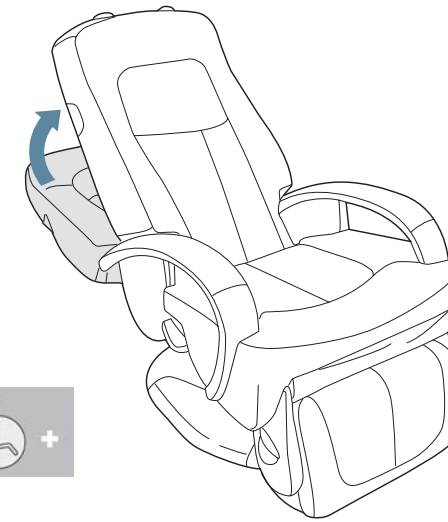

- 4. Install the head pillow**

Attach the head pillow to the top of the backrest using the hook and loop fasteners.

**YOUR HT™-270**  
requires some simple assembly  
(no tools required). Simply plug  
it in, turn it on, install the head  
pillow, and you're set to go!

# TAKE A SEAT

## 1. Adjust the backrest

Use the remote control Power Recline buttons to adjust the backrest angle for maximum comfort.

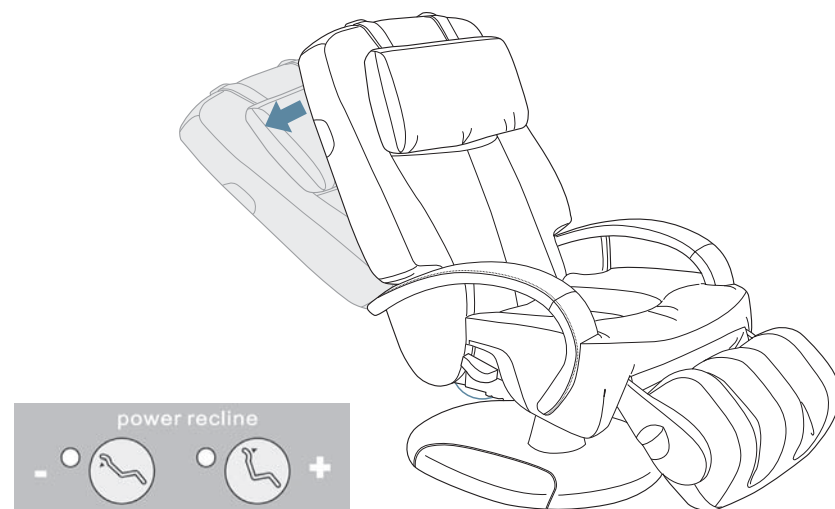

⦿ When changing direction (from Recline to Incline and from Leg Up to Leg Down), there is a slight pause while the chair gears shift. This is perfectly normal.

## 2. Adjust the footrest height

While sitting in the chair, pull up on the electric footrest lever (located on the right-hand side of the chair) to raise the footrest to a comfortable height. Release the lever.

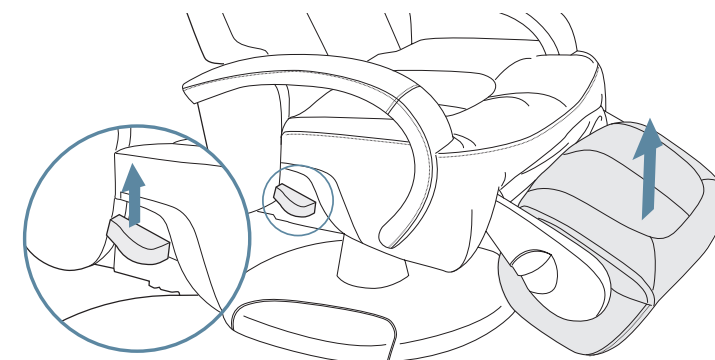

⦿ Before getting out of the chair, always lower the footrest.

Push down on the electric footrest release lever (located on the right-hand side of the chair) to return the footrest to a vertical position.

USING YOUR HT™-270 chair is easy.

Just take a seat, adjust the backrest and footrest to the desired position, and deploy the calf+foot massager (if desired). Your HT™-270 massage chair expertly soothes tired muscles from head to toe, using a wide variety of massage techniques that you control. It's a luxury you will treasure for years to come.

# TAKE A SEAT Part II

## FOR A CALF OR FOOT MASSAGE

### 1. Deploy the calf+foot massager

Pull up on the footrest release handle (located on the right side of the footrest).

For a calf massage, rotate the footrest away from the chair until it clicks into position with the calf+foot massager facing up. **Do not force the rotation of the footrest past the point at which it clicks to lock. Excess force may damage the mechanism.**

For a foot massage, rotate the footrest away from the chair just until the calf+foot massager is facing up. Do not rotate it so far that it clicks into position; the footrest should be moving freely for a foot massage.

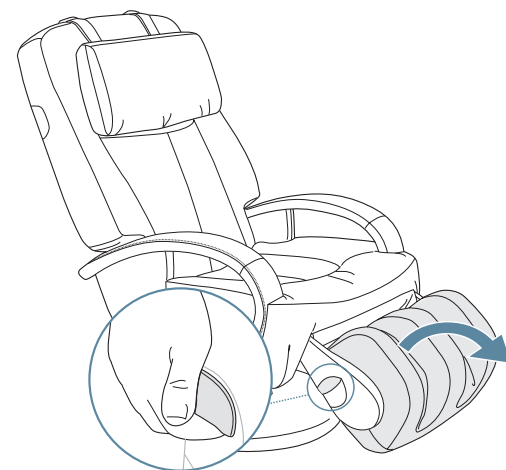

### 2. Insert your calves or feet

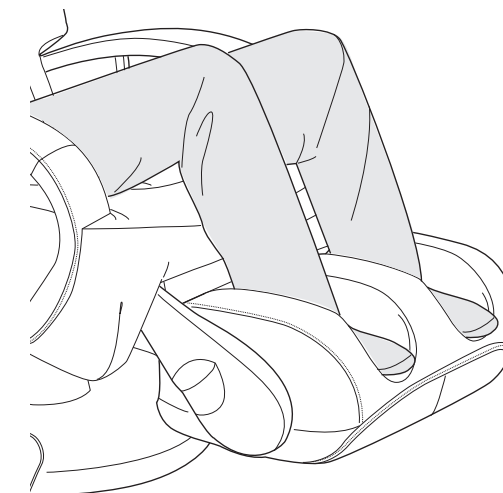
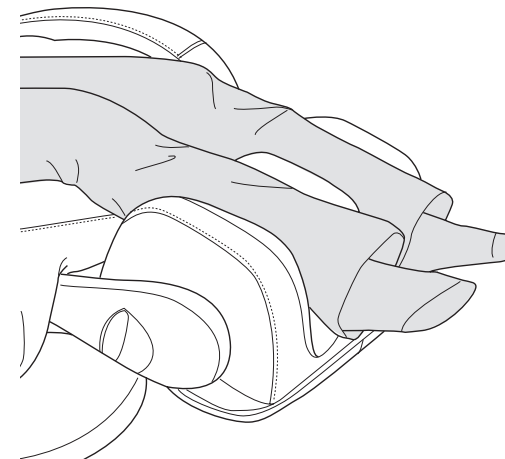

 Do not stand or sit on the calf+foot massager.

# TAKE CONTROL

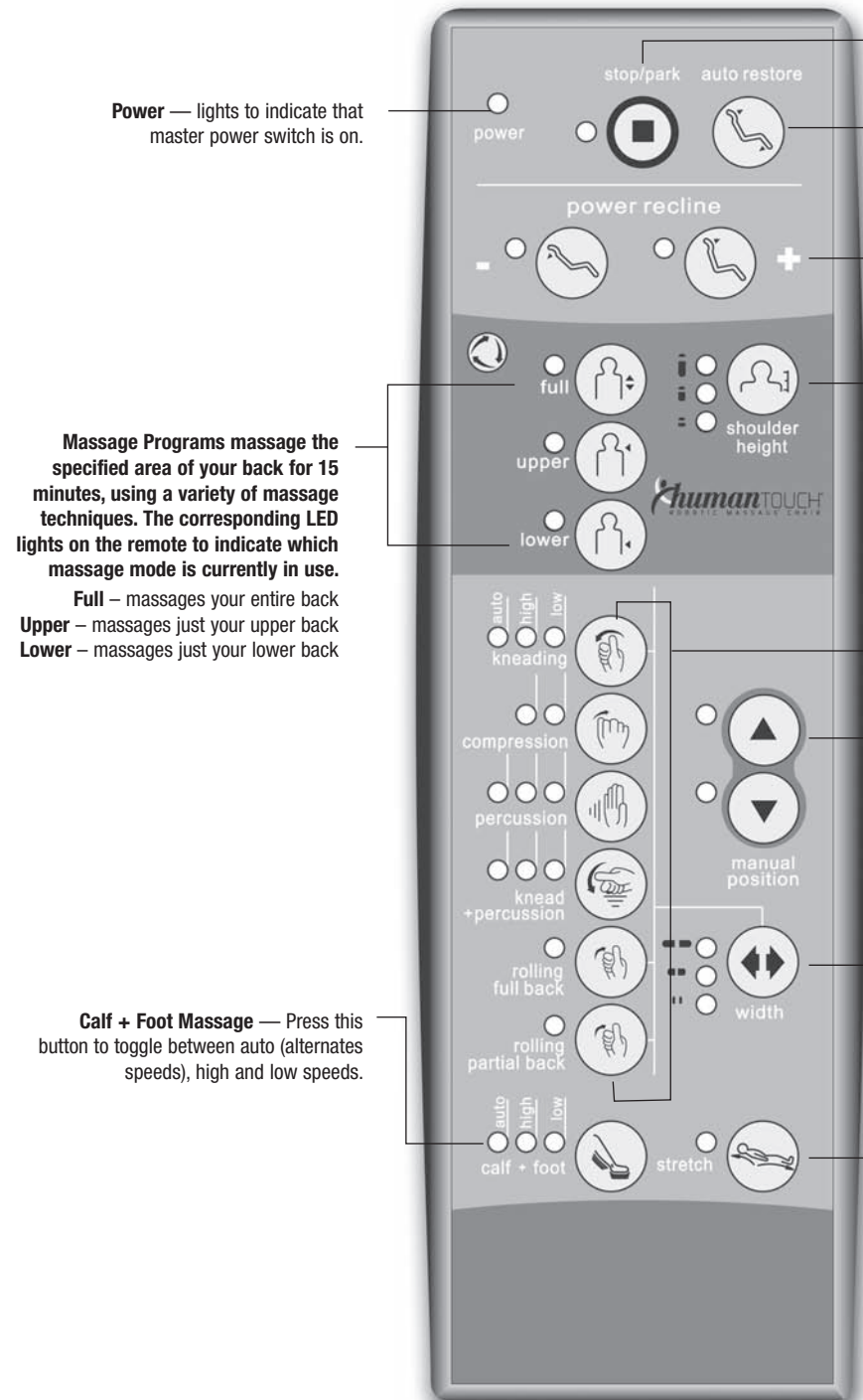

**Power** — lights to indicate that master power switch is on.

**Massage Programs** massage the specified area of your back for 15 minutes, using a variety of massage techniques. The corresponding LED lights on the remote to indicate which massage mode is currently in use.

**Full** — massages your entire back  
**Upper** — massages just your upper back  
**Lower** — massages just your lower back

**Calf + Foot Massage** — Press this button to toggle between auto (alternates speeds), high and low speeds.

**Stop/park** — stops the massage and parks the massage rollers at the top of the backrest.

**Auto restore** — With the smooth side of the footrest on top, press and hold this button until the backrest returns to the full upright and the footrest fully retracts.

**Power Recline** — Press the Power Recline buttons to adjust the backrest angle for maximum comfort.

**Shoulder Height** — Press to select tall, medium, or short, based on your height, to position the massage rollers for maximum comfort.

**Manual position** — Use this button along with one of the stationary massage modes, to set the massage rollers to the desired position on the backrest. You can press this button before or after selecting the massage mode.

**Width** — Focus or diffuse massage pressure by adjusting the width of the precision massage rollers. Select narrow, standard, or wide roller setting while in Percussion, Rolling Full Back and Rolling Partial Back massage modes.

**Stretch** — Place your legs in the calf+foot massager before using the Stretch feature. Press the Stretch button for up to 15 seconds to activate (the remote beeps twice when ready). The backrest and calf+foot massager work together automatically to perform a gentle full-body stretch.

## MESSAGE MODES



**Kneading** — kneads your back in small, circular motion on both sides of your spine simultaneously, relieving tension and soreness by lifting and stretching muscles. Kneading improves circulation and helps bring vital nutrients to the spinal area. Press to toggle between auto (alternates speeds), high and low speeds.



**Compression** — presses on spinal muscles and spinal joint areas using alternating strokes and a gentle rocking motion, emulating a technique used in sports medicine and in spinal therapy by chiropractors. Compression spreads and puts pressure on deep muscle tissue, forcing it to relax, while the rocking motion loosens spinal joints. This technique aids in muscle and joint repair due to strain from exercise, long hours bent over a desk, or just day-to-day stress, and can improve mobility and overall posture. Press to toggle between high and low speeds.

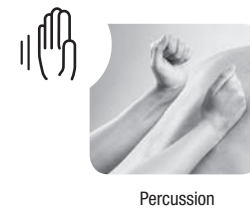

**Percussion** — alternating rapid-tapping strokes along the spine stimulate both spinal muscles and spinal joint areas, emulating the percussive massage technique used in sports medicine for deep muscle therapy. Percussion massage flexes spinal joints and relieves pressure on the spinal column, invigorating the entire back area. Press to toggle between auto (alternates speeds), high and low speeds.



**Knead+Percussion** — combines the Kneading and Percussion massage modes. Press to toggle between auto (alternates speeds), high and low speeds.



Can be used with Percussion, Kneading and Compression massage modes.

**Rolling Full Back** — rolls gently up and down your back near your spine, gently alternating side-to-side, to warm up and loosen your muscles and prepare your back for deeper massage. Rolling massage relieves muscle tension, improves circulation and relaxes the back.

**Rolling Partial Back** — applies the massage to a 3-inch-high portion of your back. Use the Spot Adjust buttons to position the massage rollers to the desired area.

NOW CHOOSE  
 A MESSAGE  
 MODE TO SUIT  
 YOUR MOOD.

Your HT™-270 massage chair lets you customize your massage using a wide variety of massage modes. Choose from four stationary massage modes and two rolling massages, or combine them. Too tired to make a decision? Just select one of the three auto programs, which alternate between massage modes and target different areas of your back. For specific sore spots, position the massage rollers to target that spot. Your HT™-270 offers maximum flexibility, to meet all of your back massage needs.

# FOR A STRONGER MASSAGE

1. Flip the head pillow over to the back of the chair.
2. Open the horizontal zipper on the front of the backrest cushion.

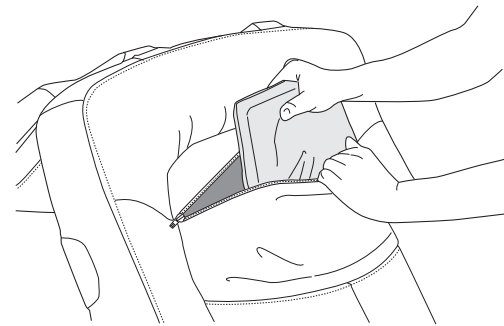

3. Remove the massage-softening pad from the pocket.
4. Close the zipper.
5. Flip the head pillow over to the front of the chair.

You can re-insert the massage-softening pad in the future, following these same steps.

*Additional massage-softening pads are available from Interactive Health®, for an additional charge.*

## WANT A STRONGER MASSAGE?

**You can easily remove the  
massage-softening pad that comes  
preinstalled in your HT™-270 chair.  
But keep it handy, in case you want  
to replace it in the future.**

# CARE AND MAINTENANCE

**To keep your product working and looking its best, please follow these simple care guidelines.**

## General Maintenance

1. Be sure to disconnect the power cord from the electrical outlet before cleaning.
2. Do not use benzene, thinner or any other solvents on your massage chair.
3. Remove dust on the backrest or armrest with a vacuum.
4. If the backrest or armrests become soiled, wipe with a damp cloth, then a dry cloth.
5. Common upholstery cleaners may be used for tough stains.
6. When cleaning the controller or around the power switch, use a dry cloth only. Never use a damp cloth to clean the controller or power switch.
7. It is suggested that you cover the chair when not in use for a long period of time.
8. The mechanics of this product are specially designed and constructed to be maintenance free. No periodic lubrication or servicing are required.
9. Foreign objects should not be inserted between the massage nodes or the unit housing.
10. When not in use for a long period of time, we recommend that the power cord be coiled and that the unit be placed in an environment free of dust and moisture.
11. Do not store near heat or open flame. Do not leave this product exposed to direct sunlight for long periods of time. This may cause fading or damage.

## Limited Three (3) Year Warranty

Please read the following warranty information for important disclosures before using your new Human Touch Technology® massage chair.

It is Interactive Health's mission to design, develop, manufacture and sell innovative, high quality massage products that create a better and healthier way of life. We appreciate your commitment to our mission and our products and are pleased to let you know that the Interactive Health®, HTT® massage chair that you purchased comes with a limited warranty. The warranty provides peace of mind that you are covered for mechanical or structural defects in workmanship within the coverage guidelines and limitations outlined below.

### Coverage Guidelines:

The warranty begins on the original purchase date and consists of:

- **Factory Service (Labor):** Interactive Health® will supply packing materials, cover return shipping to Interactive Health®, repair parts covered by this warranty and labor for repair work and return shipping to purchaser when repairs are completed.
- **Parts Only (Parts):** Interactive Health® will supply repair parts that are covered by this warranty and return shipping to purchaser for repairs performed at the factory.
- **Structural (Metal Frame):** Interactive Health® will supply packing materials and repair parts covered by this warranty and return shipping to purchaser for repairs performed at the factory.

HTT® Chair (HT™ Models)	Factory Service	Parts	Structural
New Products (Original Packaging Only)	90 days	1 year	3 years
Refurbished Products	60 days	6 months	6 months
Floor Demos (including "out of box")	NONE	6 months	6 months

In the unlikely event that your chair malfunctions or requires repair, please contact your retailer. For USA customers only, please contact Interactive Health® Customer Service at (800) 355-2762 between the hours of 8:30AM and 5:00PM PST or [cs@interhealth.com](mailto:cs@interhealth.com) for assistance. You can also send a fax to customer service at (800) 840-2940.

All warranty service requires approval and authorization by Interactive Health®. Products require a Return Merchandise Authorization Number (RMA) for any returns to the factory. For returns, the consumer is responsible for packing the product in the original box or in approved packaging that is available for sale from Interactive Health. Shipping and freight coverage under this warranty requires scheduling by Interactive Health and only includes "curb-side" pickup/delivery. Products received without a valid RMA number or one clearly marked on the box will be refused.

### General Limitations:

- The warranty is only valid within the United States and Canada provided the product has been operated according to the instructions accompanying it and has not been misused or damaged in any way that is beyond the control of Interactive Health®.
- All service covered by this warranty must be approved by Interactive Health® and repairs performed by authorized technicians.
- The warranty applies only to the massage chair; accessories or enhancements are not covered.
- Important exclusions apply to cosmetic items such as fabrics, woods, foams, padding, plastics covers, etc.
- Interactive Health® is not responsible in any way for losses, damages, or inconvenience caused by equipment failure.
- For a complete listing of warranty coverage, exclusions, and limitations, visit [www.interhealth.com](http://www.interhealth.com).
- Warranties do not apply to rental, business, commercial, institutional, or other non-residential users.
- Separate warranty terms apply to used/refurbished products including those received out-of-box. Proof of purchase (original receipt) is required for all warranty repairs.

### EXTENDED WARRANTIES:

Interactive Health® offers extended warranty programs to enhance ownership of the Interactive Health® chair! Extended warranty purchases are available within 90 days of purchase of HT™ Chairs from either the retailer or direct from Interactive Health's Customer Service Department.

Please visit [www.interhealth.com](http://www.interhealth.com) for the latest terms and pricing for extended warranties.

## SPECIFICATIONS\*

Operating Voltage:	110 -120 VAC
Power Consumption:	120 Watts
Size:	Chair (reclined) 70" L x 27.75" W x 26.25" H
Weight:	Chair 162 Lbs
Recline Angle:	120 - 170 Degrees
Rotation (Swivel) Angle:	Swivel 60 Degrees (left to right)
Number of Massage Functions:	Six (6)
Massage Head Storage:	Auto at Top
Automatic Timer Shut-Off:	15 minutes
Total Massage Stroke Length:	27.5 Inches
Rolling:	1 Speed
Kneading:	2 Speeds and Auto
Compression:	2 Speeds
Percussion:	2 Speeds and Auto
Kneading / Percussion:	2 Speeds and Auto
Stretch:	Auto
Maximum weight:	285 Lbs.
Cover Fabric Material:	Leather/Leather Match
Accessories:	Massage Softening Pad

*\*Specifications are subject to change without prior notice.*



[WWW.INTERHEALTH.COM](http://WWW.INTERHEALTH.COM)